

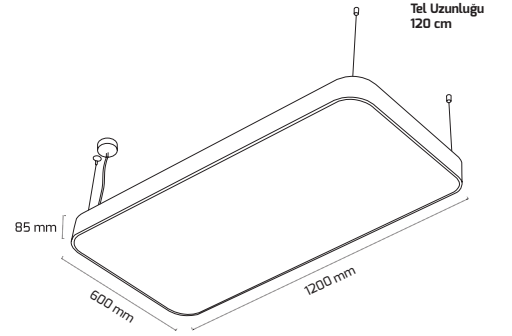

Ürün Detayı

TR

- Materyal : Alüminyum Ekstrüzyon
- Boya : Elektrostatik Toz Boya
- Led Markası : SMD / SAMSUNG
- Driver Markası : OSRAM
- Renk Sıcaklığı : 3000K - 4000K - 6500K
- Renksel Geriverim : CRI≥90
- Kontrol : ON OFF - DALI
- Optik Sistem : Pc Difüzör
- Işık Açısı : 110°
- Gövde Rengi : Beyaz - Siyah
- Çalışma Ömrü : 50.000 Saat
- Flicker : Free
- Montaj Şekli : Sıva Üzeri - Sarkıt
- Koruma Sınıfı : IP20
- Hareket Kabiliyeti : Sabit Gövde
- Giriş Gerilimi : 230-240V / 50-60Hz
- Acil Aydınlatma Kiti : 1 Saat Süreli - 3 Saat Süreli
- Ürün Ağırlığı :
- Garanti Süresi : 3 Yıl



Işık Açıları



110°

Renk Seçenekleri



Siyah

Beyaz

Driver ve Led



Teknik Özellikler

GÜÇ	IŞIK RENGİ	CRI	LUMEN	IŞIK AÇISI	KONTROL
193W	3000K	CRI≥90	20265	110°	ON-OFF - DALI
193W	4000K	CRI≥90	21230	110°	ON-OFF - DALI
193W	6500K	CRI≥80	22195	110°	ON-OFF - DALI